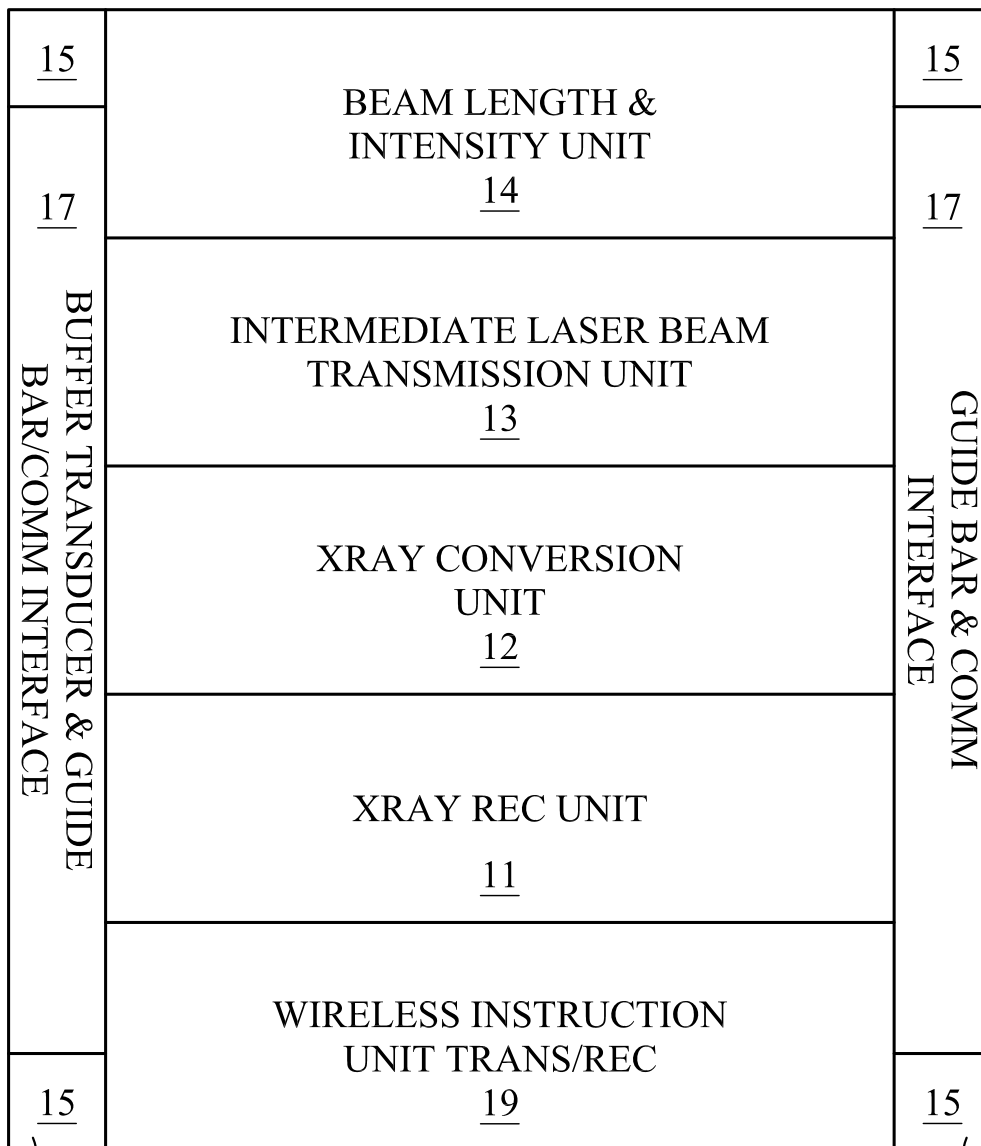

FIG. 1

10



POSITIONING  
ELEMENT

FIG. 2A

POSITIONING  
ELEMENT

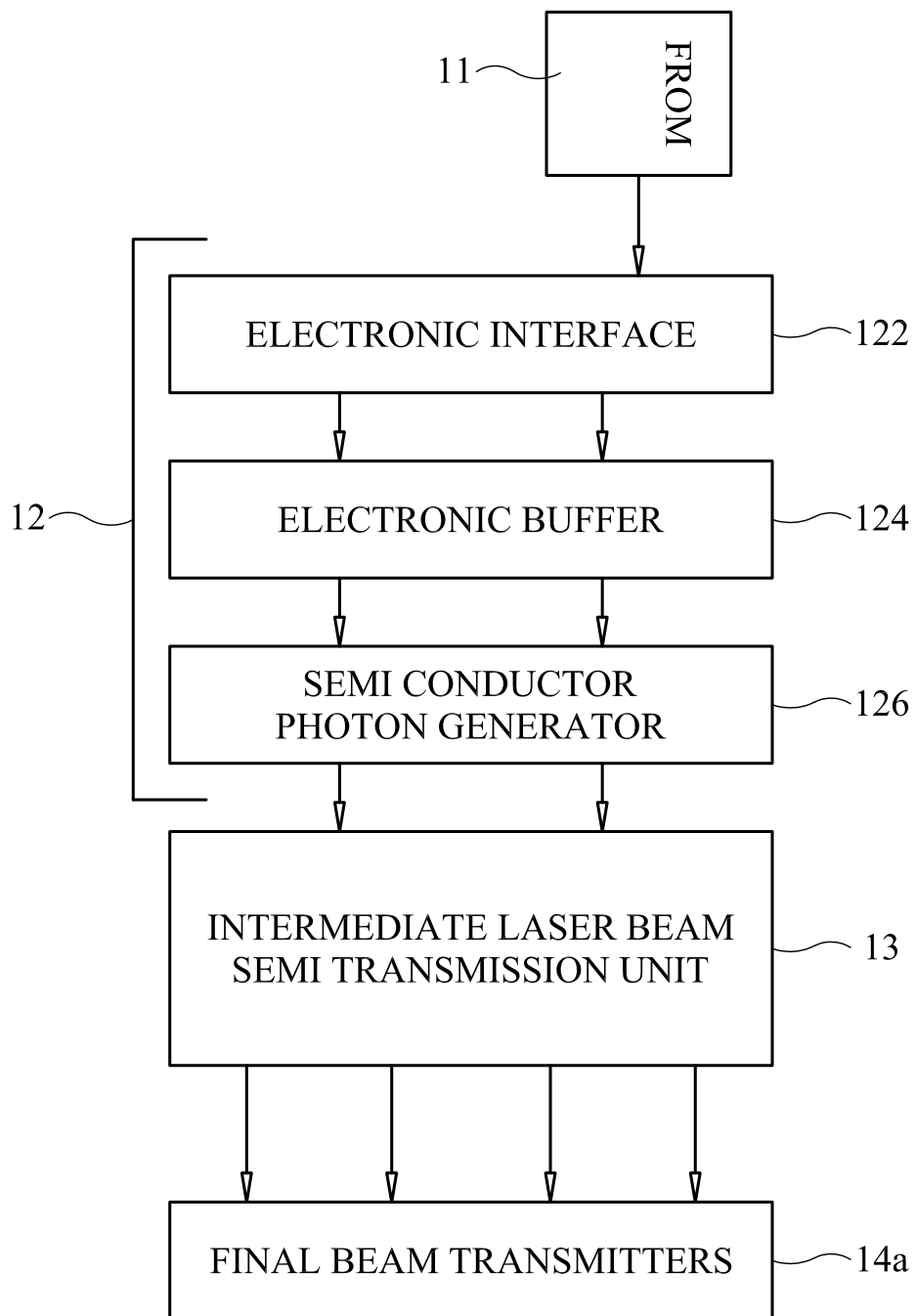

FIG. 2B

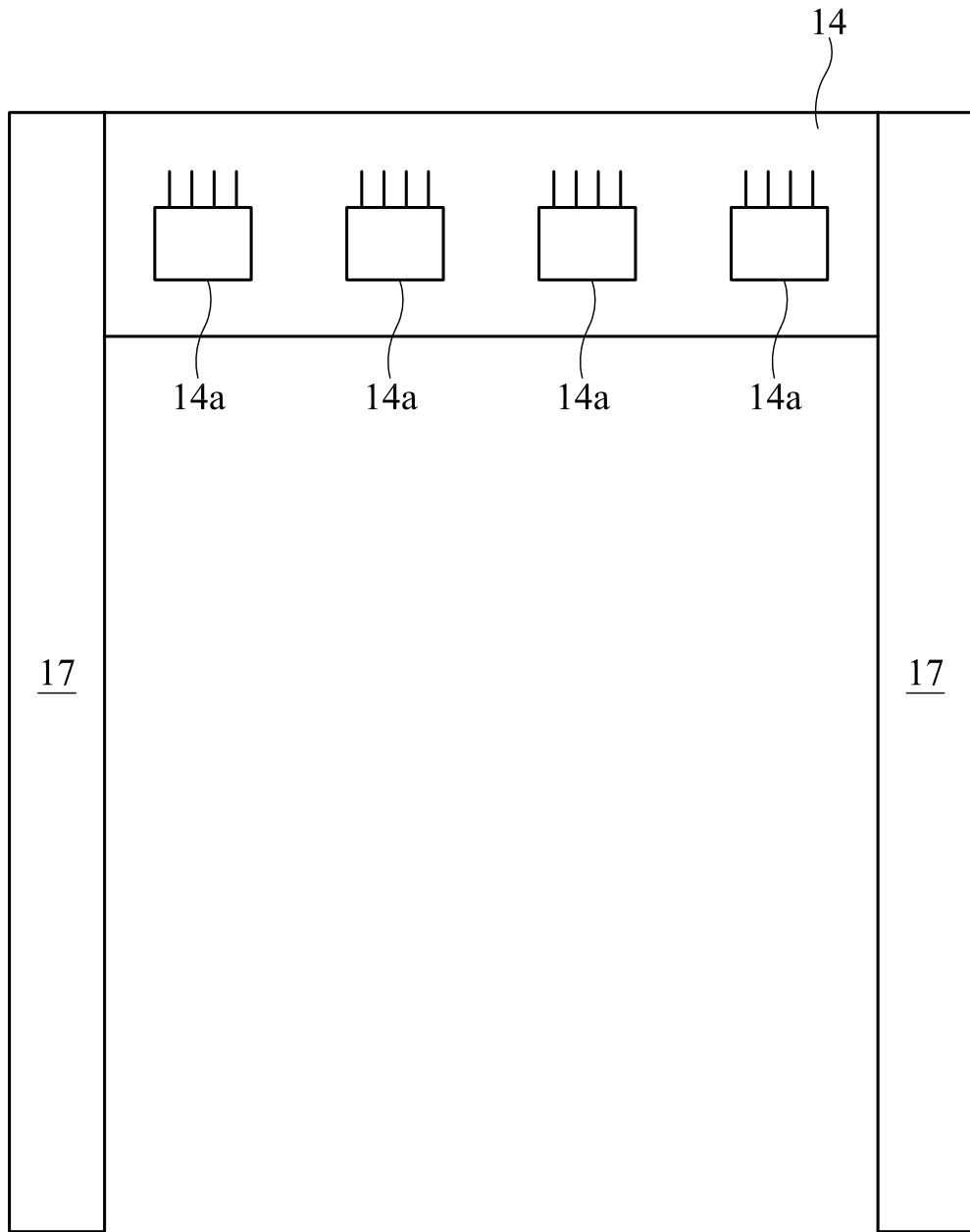

FIG. 3

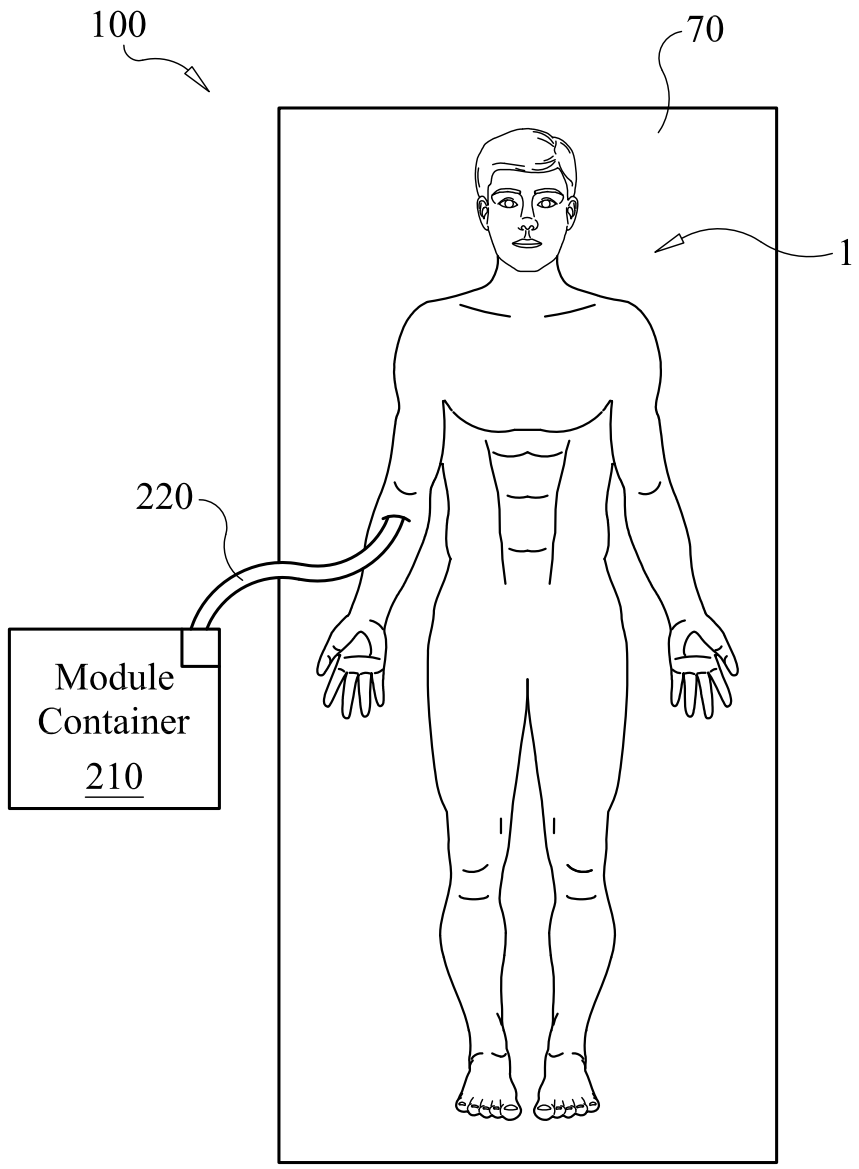

FIG. 4

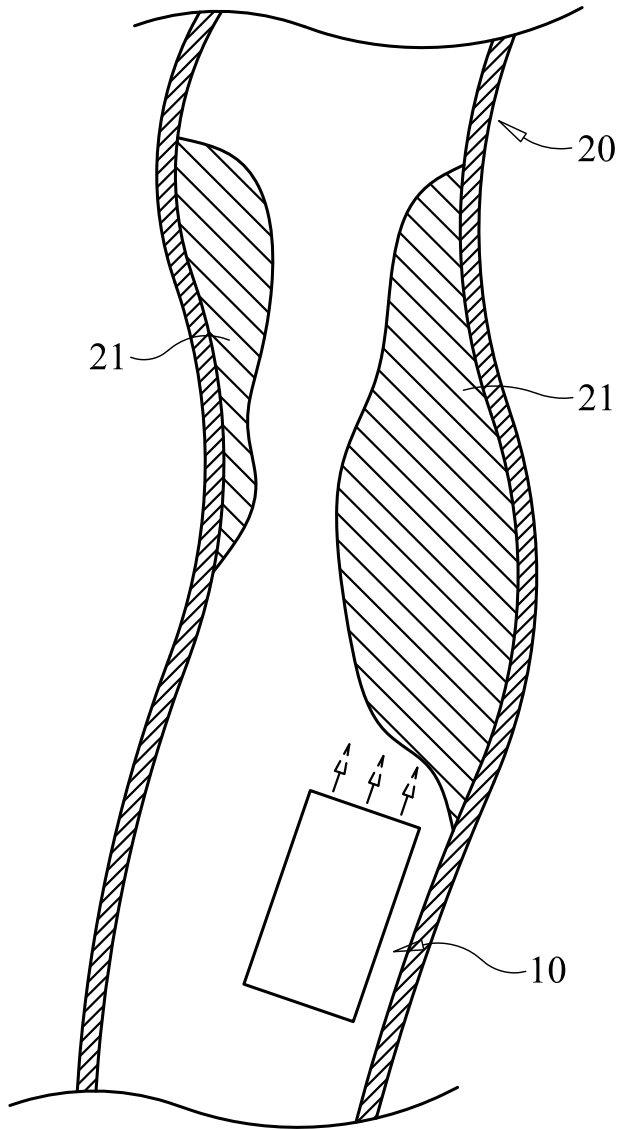

FIG. 5

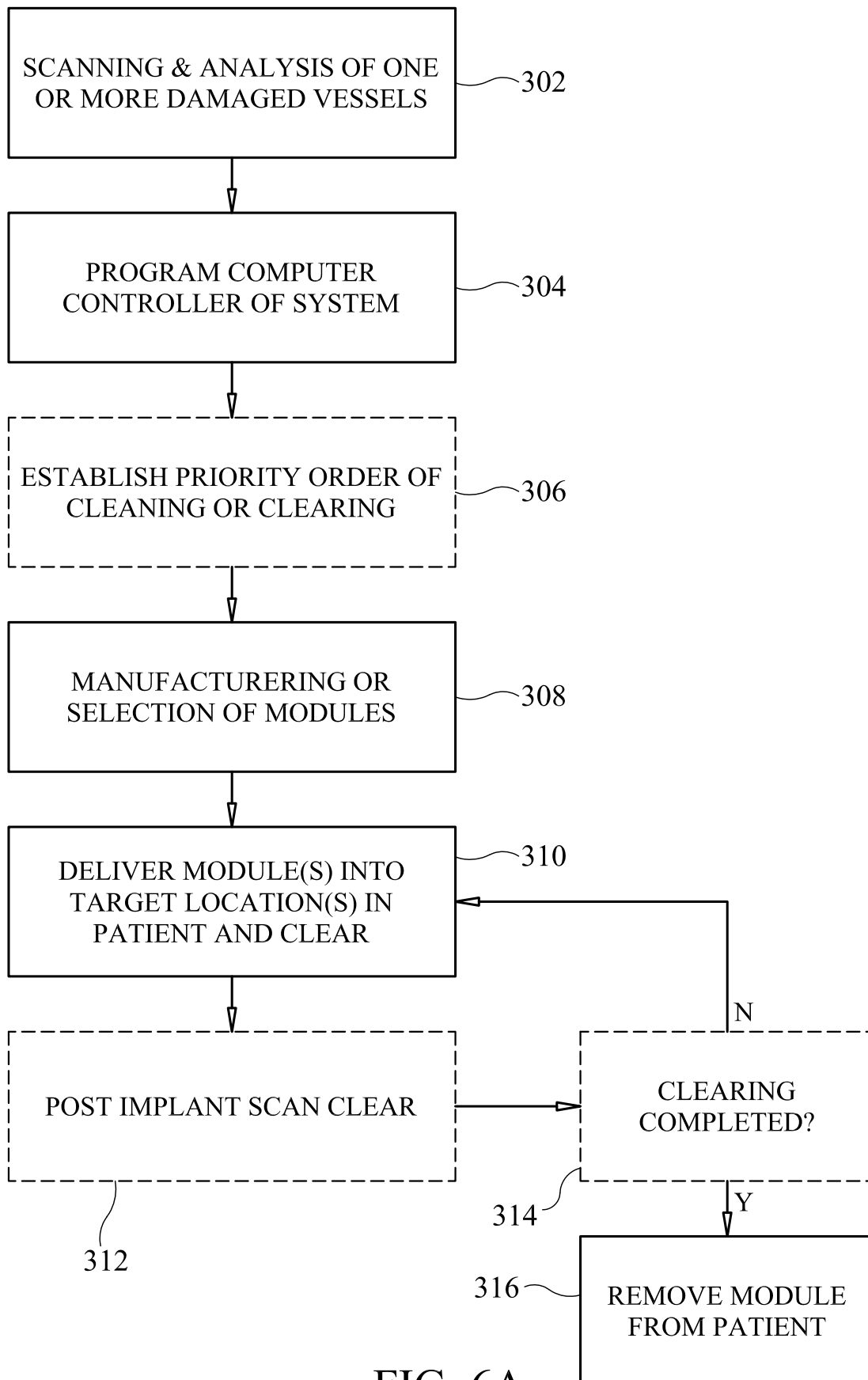

FIG. 6A

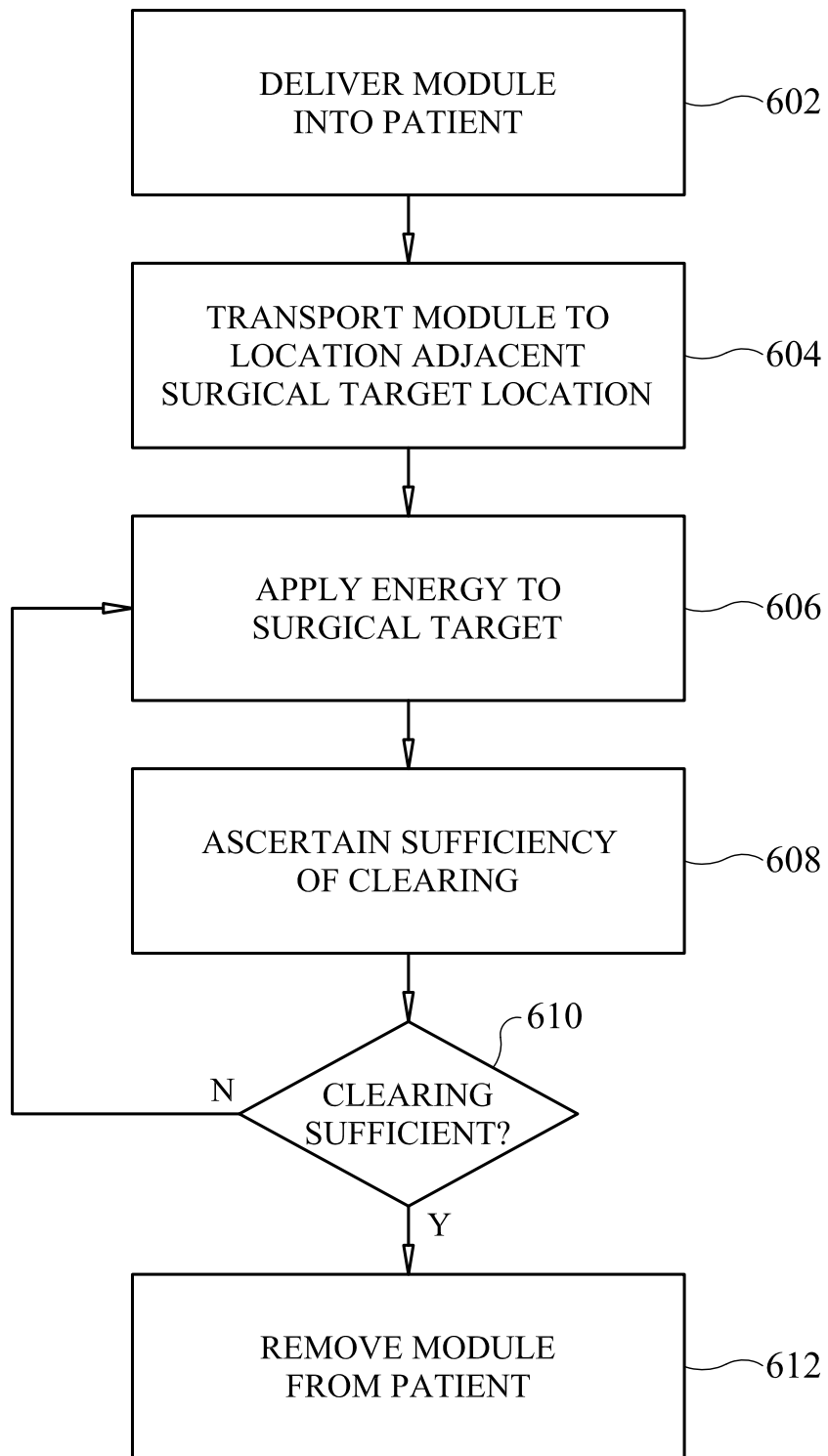

FIG. 6B



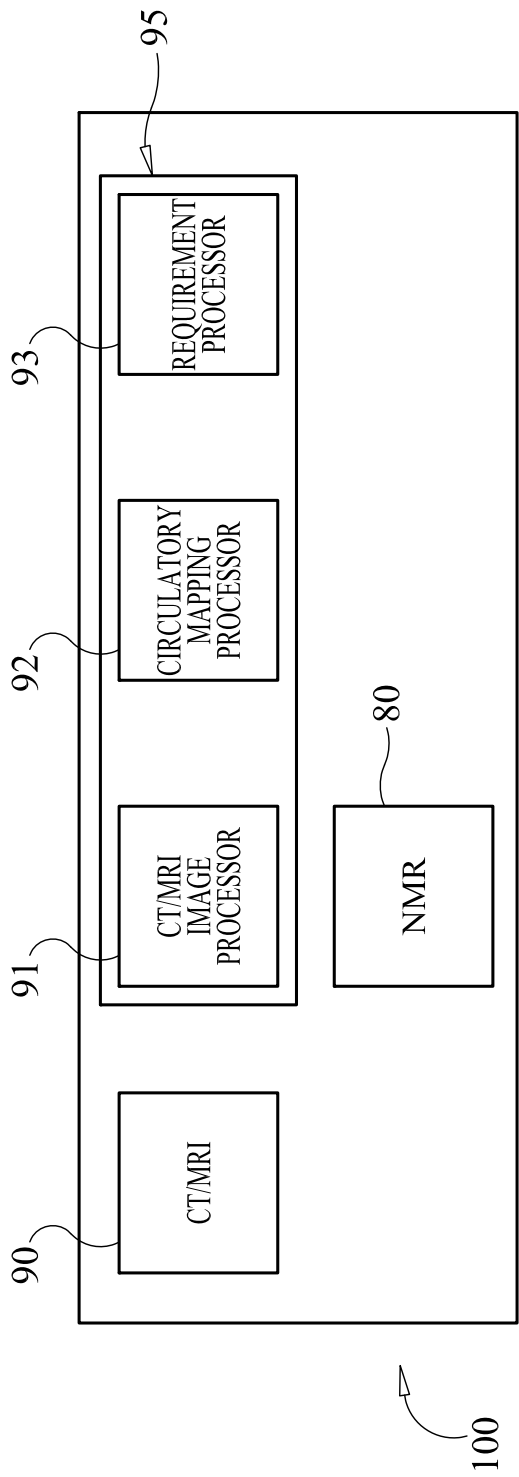

FIG. 7

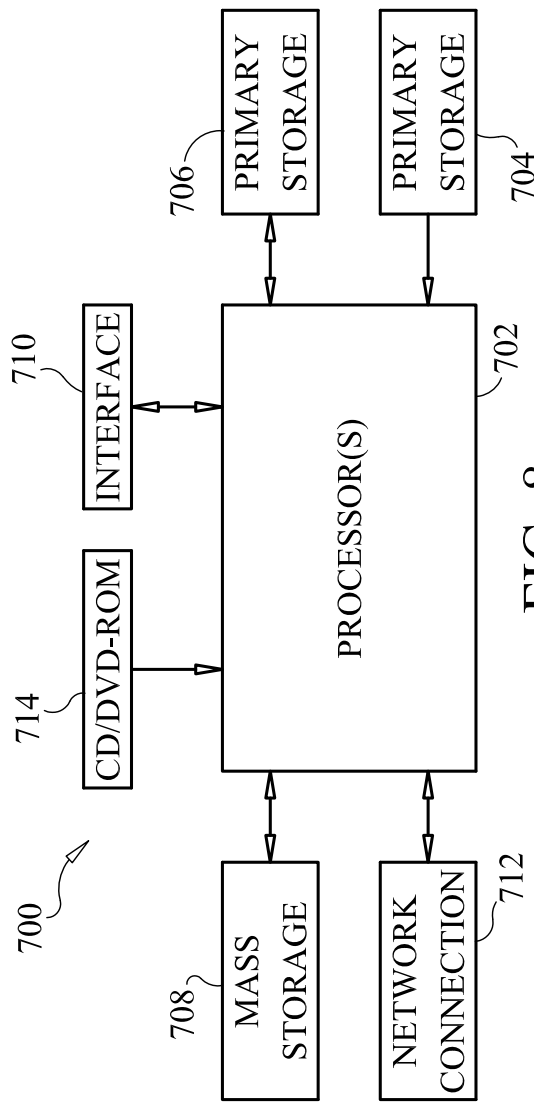

FIG. 8